



# TORTOISE PLAY-PEN



**Outdoor Shelter, Exercise Pen and Food Grazing Enclosure for Tortoises**

Thank you for purchasing Zoo Med's **NEW TORTOISE PLAY-PEN**. The following instructions will assist you with the assembly of your **TORTOISE PLAY-PEN**. If you have any questions regarding these instructions or the proper use of this item, please contact our customer service department at [zoomed@zoomed.com](mailto:zoomed@zoomed.com) or by calling **(888) 496-6633 (US and Canada only)**. Customers in other countries, please call **(805) 542-9988**.

## ASSEMBLY INSTRUCTIONS:

See the back of this sheet for complete assembly instructions.

## USING YOUR TORTOISE PLAY-PEN:

- **RECOMMENDATIONS:** Zoo Med's **TORTOISE PLAY-PEN** is designed to provide an outdoor shelter, exercise pen and food grazing enclosure for all species of tortoises 6" (15 cm) and under. Not to be used as a "complete 24 hour enclosure" (use Zoo Med's Tortoise House).
- **INSTRUCTIONS:** After assembly place your **TORTOISE PLAY-PEN** in your garden or on your outside lawn (so they can graze on your grass lawn). Make sure there are no pesticides sprayed in your garden or lawn that could come in contact with your tortoises.
- **PLACEMENT:** Place in the garden or lawn on mild to warm days only (no rain or cold weather). Place the covered sleeping side and 1/2 of the wire mesh side in the shade, leaving the other 1/2 of the open wire mesh side in the sunlight (very important). This will allow your tortoise to "bask" in the sunlight for important UVB sunlight rays or retreat to the shaded area if the tortoise desires. Always make sure your animals have water in the shaded area (we recommend Zoo Med's large or extra large Repti Ramp Bowl).
- **DURATION:** Keep outside for 1 to 3 hours only. If your tortoises bask in the sunlight, feed and/or drink water then they are happy. If they retreat to the sleeping side and stay there (for longer than 30 minutes) then you should bring them back inside your house and return them to their main terrarium/tortoise house.
- **NUMBER OF TORTOISES:** The recommended maximum number of hatchling (baby) tortoises per **TORTOISE PLAY-PEN** is 6. For adult tortoises up to 6" (15 cm) the maximum number is 2.

## WARNING:

- Never leave the **TORTOISE PLAY-PEN** unsupervised.
- Never put the **TORTOISE PLAY-PEN** where a dog or any other animal that could harm your tortoise(s) could have access.
- Keep the door closed and locked while using outside.

Extra Large Repti Ramp Bowl



Repti Calcium With D<sub>3</sub>



Repti Calcium Without D<sub>3</sub>



Natural Box Turtle Food



Natural Forest Tortoise Food



Reptisafe™



Reptivite With D<sub>3</sub>



Reptivite Without D<sub>3</sub>



Natural Grassland Tortoise Food



Powersun 100 Watt



**ZOO MED LABORATORIES, INC.**  
3650 Sacramento Dr.  
San Luis Obispo, CA 93401 U.S.A.  
Phone: 805-542-9988  
Fax: 805-542-9295  
E-mail: [zoomed@zoomed.com](mailto:zoomed@zoomed.com)  
**www.zoomed.com**

# ASSEMBLY INSTRUCTIONS

Please read all instructions prior to assembly. You will need a Phillips screw driver to complete assembly. Assembling this unit on a table top may be best.

## PARTS

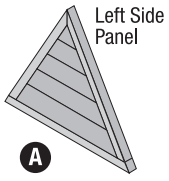

Left Side Panel

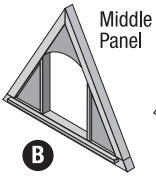

Middle Panel

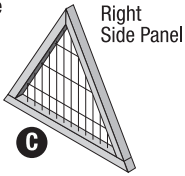

Right Side Panel

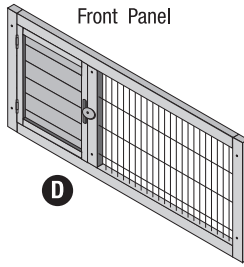

D

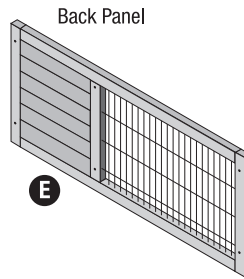

E

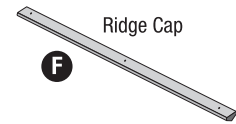

F

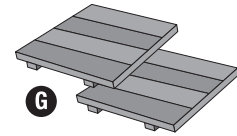

G

Floor Panels



Screw



Screw

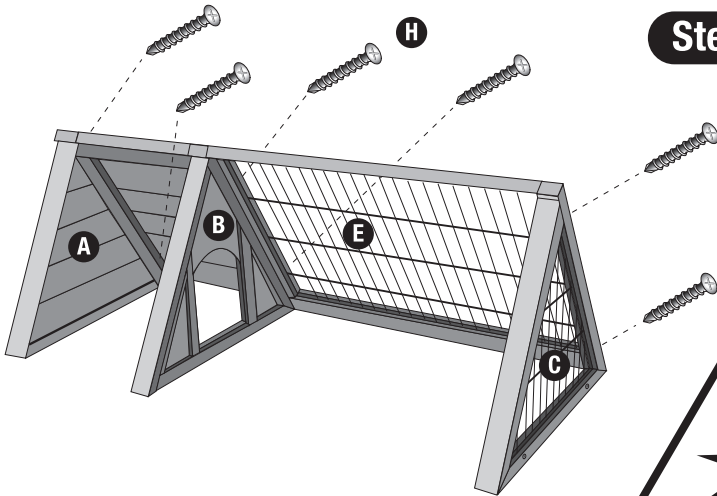

### Step 1

Attach the Back Panel (E) to the Left Side Panel (A), the Middle Panel (B) and the Right Side Panel (C) using six screws (H) as shown.

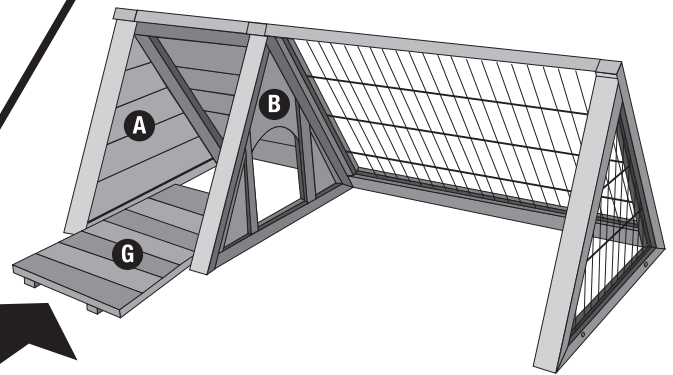

### Step 2

Slide the two Floor Panels (G) into the Left Side Panel (A) and the Middle Panel (B) as shown.

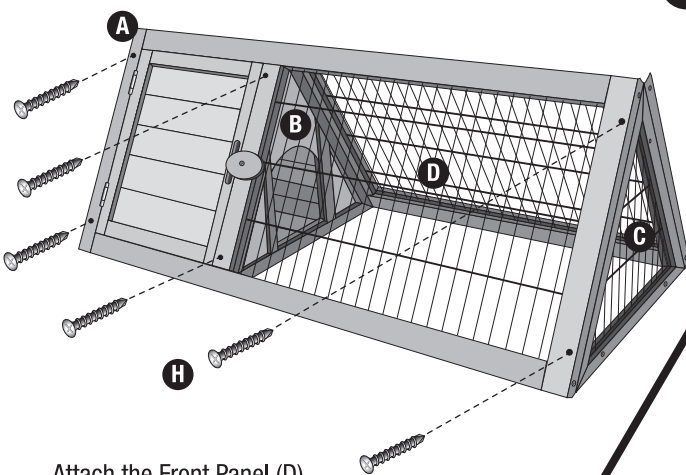

### Step 3

Attach the Front Panel (D) to the Left Side Panel (A), Middle Panel (B) and the Right Side Panel (C) using six screws (H).

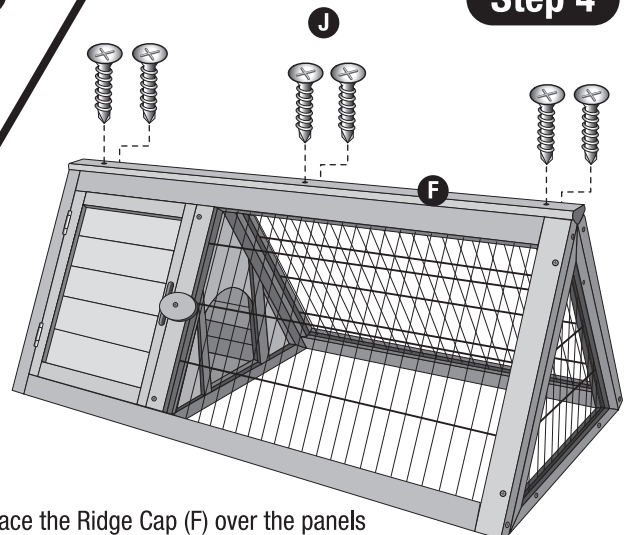

### Step 4

Place the Ridge Cap (F) over the panels and secure using six screws (J).